

DRY AGER AND THAWING REFRIGERATOR BOTTOM MOUNT CONDENSING UNIT

Project Name: _____

Project Location: _____

Model #: _____ Quantity: _____

Available Warehouse: _____

EB Series

Model: EDA2



Refrigeration System

- Bottom mounted, self-contained and fully detachable Blizzard R290 condensing unit uses environmentally friendly, EPA-compliant R290 refrigerant with zero (0) Ozone Depletion Potential (ODP) and three (3) Global Warming Potential (GWP). Blizzard R290 is easily replaceable and requires no on-site brazing.
- Dual air paths with multiple electronically commutated (ECM) four fan motors optimize circulation and accelerate the meat maturation process.
- Full-length air duct and airflow guard ensure optimal cold air circulation.
- Air circulation guard keeps floor vents from obstruction.
- Time-initiated and temperature-terminated auto defrost cycle for seamless operation.
- Large capacity, corrosion-resistant condenser and evaporator coils.
- Self-maintaining, energy-efficient condensate drain pan requires no external drains or electric heaters.
- High performance, auto-reverse condenser fan motor supports compressor ventilation and condenser coil cleaning.
- Pressure relief devices allow rapid cabinet re-entry.
- Pre-wired and ready to plug, 115V/60Hz/1Ph, NEMA 5-15P.

Cabinet Construction

- Heavy duty stainless steel exterior with rounded corners for a hazard-free workspace.
- Insulated interior wall between both compartments.
- PFOA free, ceramic coated aluminum interior walls diffuse infrared rays which enhance the meat maturation process.
- High quality stainless steel interior floor.
- Galvanized steel top, bottom and rear.
- 2.5" thick high density polyurethane insulation.
- Four 5" swivel casters with locks on front set and two front leg stabilizers.

Lighting

- Shielded LED bar lighting with on/off switch provides bright, high color illumination at lower heat output.

Doors

- Low emissivity double glass panes and matte finish aluminum door frames for glass doors.
- Self-closing with adjustable torsion system for a positive seal.
- Snap-in magnetic door gasket make cleaning and replacement an easy process.
- High strength, die-cast door handles.
- Pre-installed door locks keep your items safe from theft.
- Field reversible.

Shelving

- Four stainless steel shelves per section.
- Height adjustable stainless steel clips.

Temperature Control

- Multi-function digital controller with easy to read LED display.
- Factory preset temperature, 35°F. Temperature setting range from 33°F to 54°F.
- Audible overheat protection alarm for compressor and condenser coil.

Options

- Stainless steel hangers and hooks.
- Additional shelving.
- 3" swivel casters with locks.
- 3.5" – 6" height-adjustable and interchangeable legs.



Please visit our website for updated Energy Efficiency information

| Ref/ Frz/Dual | Doors | Capacity Cu. Ft. | Shelves | Refrigerant | HP | Power V-Hz-Ph | Amps | Crated Weight | Exterior Dimensions | | |
|------------------|-------|---------------------|---------|-------------|---------|------------------|------|--------------------|---------------------|--------------------|-----------------|
| | | | | | | | | | L | D | H* |
| REF | 2 | 50 | 8 | R-290 | 1/3 x 2 | 115-60-1 | 7 | 609 lbs (276kg) | 54.125" (1375mm) | 33.125" (841mm) | 77" (1956mm) |

(†)Based on evaporating temperature of 23°F (-5°C) & condensing temperature of 131°F (55°C). (►) Product capacity is calculated based on standard industry figures. (✳) Reference plan view for clarification on caster/unit height. If dimensions and capacity are critical, please contact Everest Refrigeration. Blizzard R290 replacement is at the sole discretion of Everest Refrigeration. Specifications subject to change without notice.

DRY AGER AND THAWING REFRIGERATOR BOTTOM MOUNT CONDENSING UNIT

EB Series

Model: EDA2

DIMENSIONAL DATA

| | | |
|--------------------------|----|------------------|
| External Dimensions | L | 54.125" (1375mm) |
| | D | 33.125" (841mm) |
| | H* | 77" (1956mm) |
| Crated Weight | | 609 lbs. (276kg) |
| Doors/Drawers/Lids | | 2 |
| Max Weight Support (LBS) | | - |

STORAGE DATA

| | |
|------------------------|----|
| Net Capacity Cu. Ft. ▶ | 50 |
| Shelves | 8 |
| Barrels | - |
| 20 oz. Bottles | - |
| 12 oz. Bottles | - |
| 12 oz. Cans | - |
| 8" Mugs | - |
| # of Pans (Top) | - |
| # of Pans (Drawer) | - |
| Dividers | - |
| Trays | - |

ELECTRICAL DATA

| | |
|------------------------|--|
| Voltage | 115-60-1 |
| Full Load Amperage | 7A |
| Feed Wires with Ground | 3 |
| Cord Length | 9ft |
| NEMA Plug Type |  NEMA 5-15P |

REFRIGERATION DATA

| | |
|---------------------|----------|
| Compressor Mounting | Bottom |
| Refrigerant | R-290 |
| Compressor HP | 1/3 x 2 |
| BTU/HR † | 2311 x 2 |

KEY

| | | | |
|----|------------|------|---------------|
| D | Door | R | Refrigerator |
| L | Lid | REF | Refrigerator |
| H | Half Door | F | Freezer |
| FD | Full Door | FRZ | Freezer |
| SD | Solid Door | DUAL | REF/FRZ Combo |
| GD | Glass Door | DR | Drawer |

| | | | | | |
|--|-----------|-------|------|----|------|
|  | Elevation | Right | Plan | 3D | Back |
| | | | | | |

PLAN VIEW

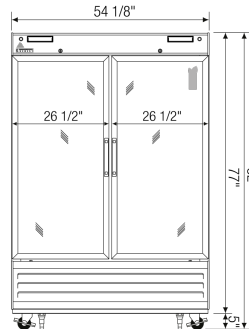

FRONT

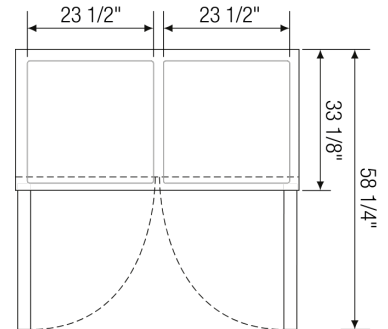

TOP

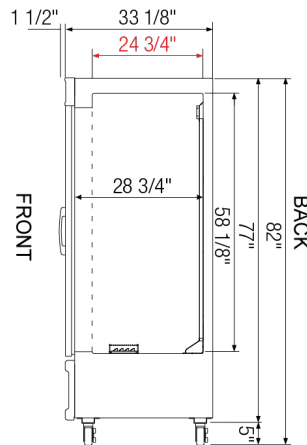

SIDE

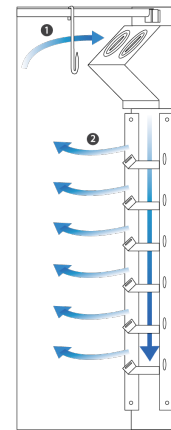

AIRFLOW

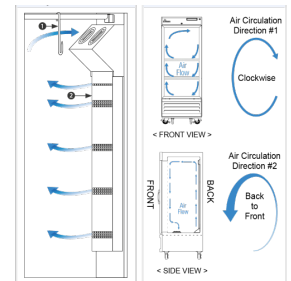

ACCESSORIES & OPTIONS

| Part Number | Description |
|----------------------------|--|
| Additional Shelving | Contact Everest Refrigeration for more information. |
| AJL03-00 | Interchangeable Leg for Caster (Optional) |
| CASA3-01 | 3" Overall Height Caster Assembly - (2) Front (2) Rear |
| MHA02-00* | Meat Hanger Assembly for EDA2 |

(†) Based on evaporating temperature of 23°F (-5°C) & condensing temperature of 131°F (55°C). (▶) Product capacity is calculated based on standard industry figures. (✖) Reference plan view for clarification on caster/unit height. If dimensions and capacity are critical, please contact Everest Refrigeration. Blizzard R290 replacement is at the sole discretion of Everest Refrigeration. Specifications subject to change without notice.