



EF1A-FS/EF2A-FS

One and Two Section Full Stainless Freezer

EF1A-FS/EF2A-FS
10/30/20
Item # 13562

W x D x H

27" x 29.63" x 81.63"
(including 4" casters)

W x D x H

54.38" x 29.63" x 81.63"
(including 4" casters)



Item #: _____
 Project: _____
 Qty: _____
 AIA#: _____

Features

- Energy efficient interior LED light
- Environmentally friendly R290 hydrocarbon refrigerant
- Solid state digital controller with temperature alarms and LED display (Fahrenheit or Celsius)
- Self-closing door(s) is field reversible
- Stainless steel exterior door(s) come standard with lock(s)
- Stainless steel interior floor with aluminum sides, rear, and top
- Time initiated automatic defrost
- Energy efficient heated condensate removal
- Heavy duty grey epoxy coated shelves are adjustable in 1/2" increments; 3 per section. 105 lbs. capacity
- Aluminum shelf supports
- Standard with 4" casters (two with brakes)
- 9 ft. cord and plug
- Container Qty:
ER1A-FS: 47
ER2A-FS: 28



Dimensions / Capacity

	One Section EF1A-FS	Two Section EF2A-FS
Interior Storage Capacity (CF) (AHAM)	17.74 ft ³	38.54 ft ³
Overall Width x Depth	27" x 29.63"	54.38" x 29.63"
Height (including 4" casters)	81.63"	81.63"
Door Opening (W x H)	22.25" x 52.1"	22.9" x 52.1"
Depth with Door Open at 90°	55.38"	55.38"
Adjustable Shelves	3	6
Shelf Dimensions (W x D)	21.5" x 23.1"	24.3" x 21.7"
Crated Shipping Weight	279 lbs	523 lbs
Crated Length x Depth x Height	31.5" x 28.75" x 84"	58" x 31.5" x 84"

Electrical / Refrigeration

	One Section EF1A-FS	Two Section EF2A-FS
Voltage	115/60/1	115/60/1
HACR Breaker	15.0 Amps	15.0 Amps
Electrical Connection (NEMA)	5-15P Ⓢ	5-15P Ⓢ
Voltage Range	103-127	103-127
Ambient Temp. Range	45° to 100°F	45° to 100°F
Control Setpoint Range	-5° to 5°F	-5° to 5°F
Amperage	3.2	4.7
Energy Consumption (kWh/day) @ASHRAE	4.62	8.8
Approx. Nominal Compres. BTU/HR (HP)	1399(1/3HP)	2074(1/2HP)
Refrigerant / Charge Amount (oz.)	R290 / (3.5oz)	R290 / (4.2oz)

Options

- Additional epoxy shelves
- HS-5511(1 section)
- HS-5512 (2 section)

Warranty

- * 2 Year - Parts and Labor on entire machine.
 5 Year - Parts on Compressor
 Valid in United States, Canada, Puerto Rico and U.S. Territories. Contact factory for warranty in other countries.



EF1A-FS/EF2A-FS

One and Two Section Full Stainless Freezer

EF1A-FS/EF2A-FS
10/30/20
Item # 13562

FRONT VIEW

SIDE VIEW

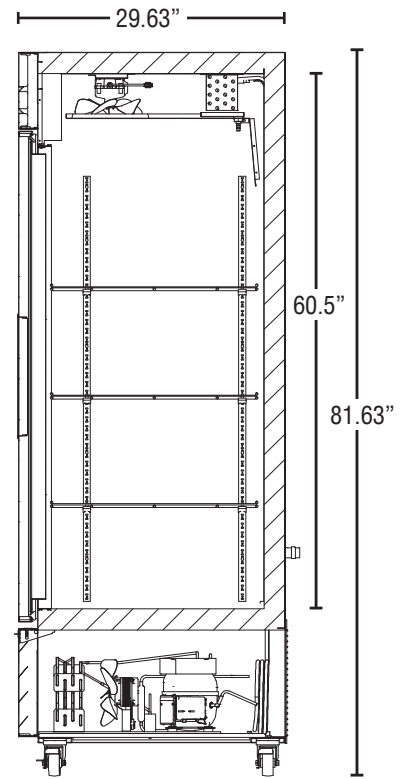
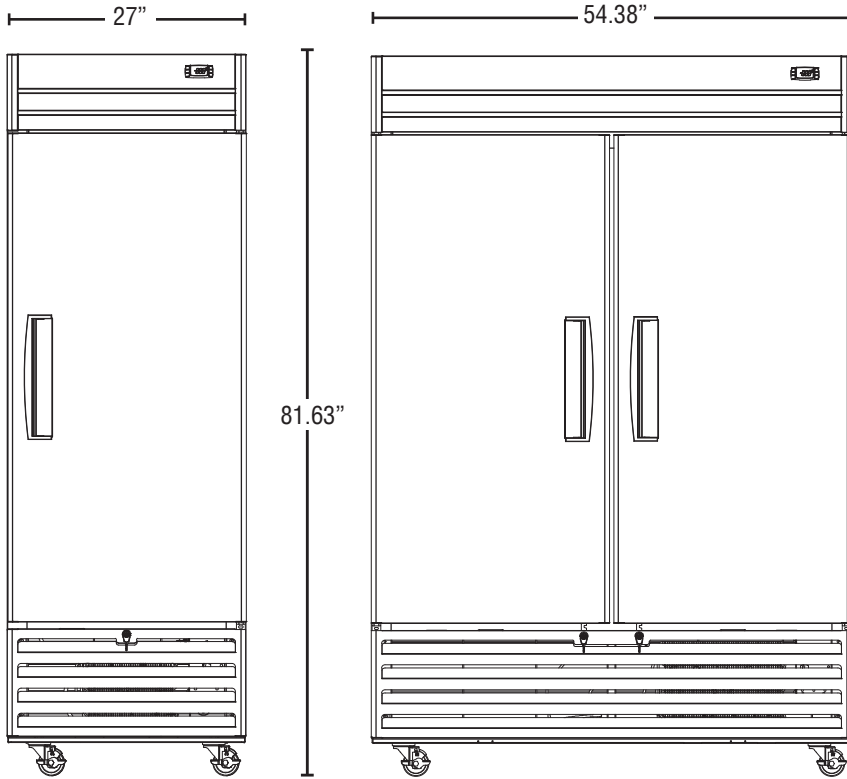

PLAN VIEW

