



ICEU220

Features

- Space-saving 24" (623 mm) wide undercounter design.
- Produces up to 251 lbs (114 kg) of ice per day.
- *Harvest Assist* provides consistent ice production for the life of the ice maker while reducing energy consumption and increasing capacity.
- *Pure Ice®* exclusively by Ice-O-Matic. Built-in antimicrobial protection for the life of the ice maker inhibits bacteria growth on ice maker surfaces. Ice-O-Matic's optional water filtration system provides protection against unpleasant tastes, odors and scale formation.
- Durable, electroless nickel plating on all evaporator plates ensures reliability.
- *Longest warranty in the industry.* Purchase an Ice-O-Matic water filter with your cube ice maker, replace the filter every six months, and the evaporator warranty is extended to 7 years parts and labor (available in the U.S. and Canada only).
- Constructed from corrosion-resistant stainless steel and fingerprint-proof plastic.

Options & Accessories

WATER FILTERS			
Ice Machine Model	Manifold		Inline
	System	Replacement	System
ICEU220	IFQ1	IOMQ (I)	IFI4C / IFI8C
ICEU225			
ICEU226			

Ice Maker Warranty

Every Ice-O-Matic ice maker is backed by a warranty that provides both parts and labor coverage.

- Three years **Parts** and **Labor**.
- Five years **Parts** coverage on the evaporator and compressor.
- Seven years **Parts** and **Labor** on the evaporator when you purchase an Ice-O-Matic water filter with your cube ice maker and replace the filter every six months (available in the U.S. and Canada only).

Ice Form



CUBE

FULL CUBE DIMENSIONS	
W x D x H (in.)	7 ⁵ / ₈ x 7 ⁵ / ₈ x 7 ⁵ / ₈
W x D x H (mm)	22 x 22 x 22
HALF CUBE DIMENSIONS	
W x D x H (in.)	3 ⁵ / ₈ x 7 ⁵ / ₈ x 7 ⁵ / ₈
W x D x H (mm)	10 x 22 x 22

Space-Saving Solutions

- Front air discharge design for compact spaces.
- Low profile top saves counter space.
- Stores up to 70 lbs (32 kg) of ice.
- Easy front access to ice.
- Available with an air-cooled or water-cooled condenser.



Air and Water Cooled

- A. Ice maker water in, 3/8" FPT.
- B. Bin and ice maker drain, 3/4" FPT.
- C. Hole for electrical connections, 7/8" (Cord on 115V).
- D. Condenser water in, 3/8" FPT (water cooled units only).
- E. Condenser water out, 1/2" FPT (water cooled units only).

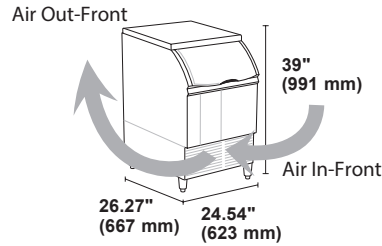
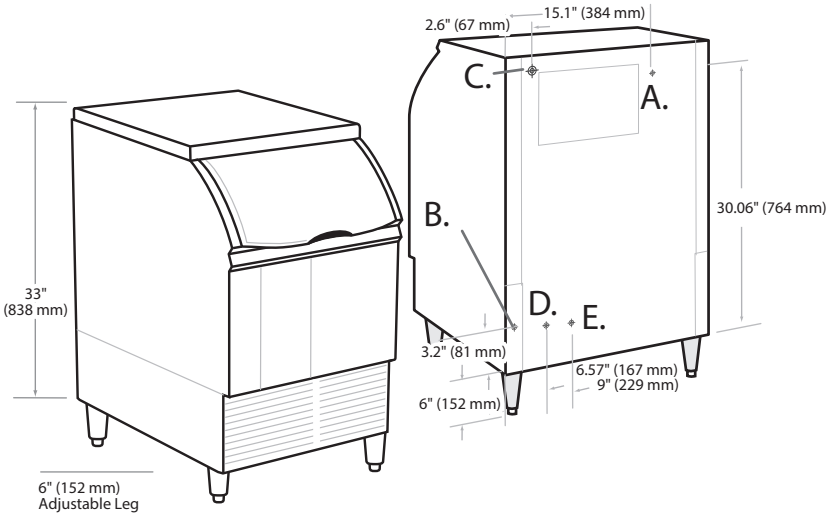

Front & Rear View

ICEU220/225/226 SELF CONTAINED CUBE ICE MAKER

Operating Requirements

	MINIMUM	MAXIMUM	
		60 Hz	50 Hz
Ambient Temp. Range Air	50°F (10°C)	100°F (38°C)	110°F (43°C)
Water Temp.	40°F (4.4°C)		
Water Pressure	20 PSIG (1.4 BAR)	60 PSIG (4.1 BAR)	

Dimensions

ALL MODELS	
W x D x H (in.)	24.54 x 26.27 x 39
W x D x H (mm)	623 x 667 x 991

Specifications

Model Number	Cond. Unit	Ice Production per 24hrs		Water Usage gallons per 100 lbs of Ice 90°F air/70°F water		kWH Used per 100 lbs of ice @ 90°F air/70°F water	Voltage Characteristics	Min. Circuit Ampacity	Fuse Size	Approx. BTUs per hour**
		70°F air/50°F water lbs (kg)	90°F air/70°F water lbs (kg)	Potable	Condenser					
ICEU220A★	Air	238 (108)	175 (79)	25.0	-	8.80	115/60/1	11.9	15	4,609
ICEU220W*	Water	251 (114)	193 (88)	37.1	175	6.60		8.9		4,288
ICEU225A	Air	211 (96)	143 (65)	32.7	-	8.80	220-240/50/1	4.9	16	3,774
ICEU225W	Water	210 (95)	174 (79)	36.6	156	6.30		4.1		3,780
ICEU226A★	Air	241 (109)	168 (76)	25.0	-	9.20	208-230/60/1	6.0	15	4,321
ICEU226W	Water	232 (105)	174 (79)	36.6	179	6.59		4.4		4,263

**BTUH is calculated 0°F Evaporator, 100°F Condensing, and 33 PSIG.

NOTES:

- Number of Wires: 3 (including ground)
- Approx. Shipping Weight lbs (kg): ICEU220A 160 (73) • ICEU220W 160 (73) • ICEU225A 160 (73) • ICEU225W 160 (73) • ICEU226A 160 (73) • ICEU226W 160 (73)
- Refrigerant Type: R404A
- *Cordset included with 115V units.

★ENERGY STAR qualified machine. Please see our website www.iceomatic.com for the latest list of ENERGY STAR qualified machines and available rebates