

Project _____

Item Number _____

Quantity _____

SRM80+ Mixer



*Shown with optional PTO

80 Quart (qt.) Floor Model Mixer

MADE IN THE USA

Model:

➤ SRM80+: 80 QT. FLOOR MODEL MIXER



Floor Model Mixer

Features:

- 3 hp capacitor start motor
- Variable Speed Drive: 4 fixed speeds or any speed in-between
- Change speeds without having to stop the mixer
- Two-piece, stainless steel, dishwasher safe safety guard
- Heavy-duty stainless steel bowl
- #12 Power Take-Off (PTO) hub
- Interlock switches protect operator from injury if safety guard is open or bowl is lowered
- Hardened alloy gears in transmission
- Low voltage protection prevents accidental start up after power failure
- Durable NSF approved hybrid epoxy/polyester powder coat finish

Standard Accessories:

- 15 minute timer
- 80 qt. stainless steel bowl
- Dough hook
- Batter beater
- Wire whip
- Ingredient chute
- Bowl scraper
- Power bowl lift

Optional Accessories:

- Splash ring
- Cover
- Sweet dough beater
- 80 qt. pastry knife
- Four wing beater
- Bowl truck

Optional Attachments:

- VS9 vegetable slicer with adjustable knife
- VS9H vegetable shredder with plate holder and 3/16" plate (additional plate size variations, grater plates, and julienne plate available)
- ALMFC12 meat and food grinder

Warranty:

- Two year, on-site parts and labor

Univex Corporation



WE RAISE THE BAR. WE SET THE STANDARD.

80 Quart Floor Model Mixer

SRM80+

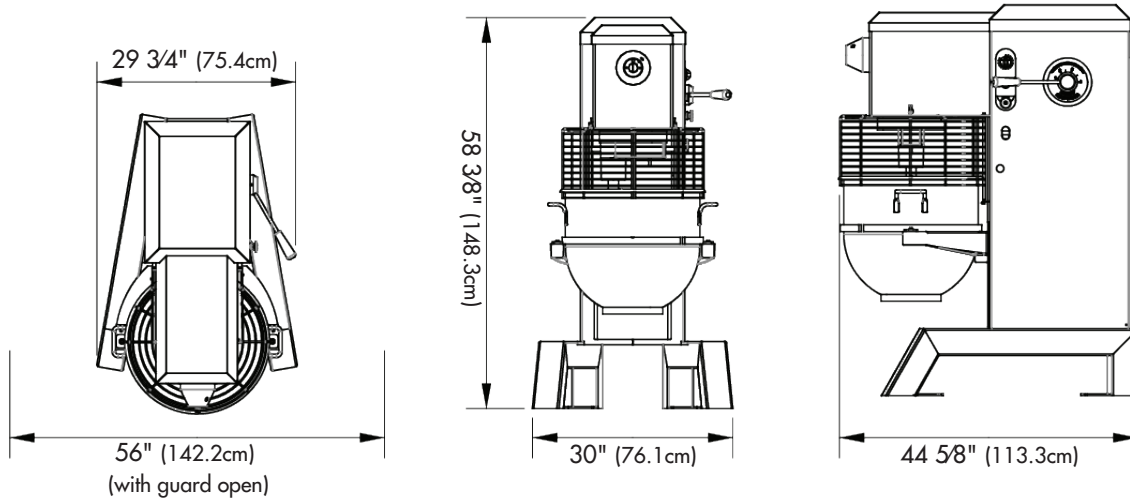

*Shown with optional PTO

Shipping Information

Net Weight	Shipping Weight	Overall Dimensions	Cubic Measure
835 lbs. (378.7Kg)	1000 lbs. (453.6Kg)	66" (167.6cm) H x 41" (104.1cm) W x 51" (129.5cm) D	79.9ft. ³ (2.26M ³)

*The weight and dimensions of the pallet are included in the weight and dimensions above.

NEMA #: 6-20-P

Electrical Information (60Hz)			
Attached 6 foot cord	Voltage	Phase	Amps
Standard Voltage	208-240	1	16.0-16.8
Optional Voltage	208-240	3	8.0-8.5
	460	3	4.0

Mixer Speeds				
Speed	1	2	3	4
Beater Shaft (RPM)	90	166	263	395
PTO (RPM)	90	160	255	387

Bowl Capacity: 80 qts. (75.7 liters)

Motor: 3 hp capacitor start

Controls: Momentary contact stop & start buttons and contactor

Bowl Lift: Ergonomic hand operated crank, self locking in top and bottom position

Lubrication: Oil bath

Transmission: Featuring hardened alloy gearing and torque sensing variable speed pulleys



Univex Corporation
www.Univexcorp.com

3 Old Rockingham Rd
Salem, NH 03079
United States of America

TEL: (800)258-6358
INTL TEL: (603)893-6191
FAX: (800)356-5614
INTL FAX: (603)893-1249